

## Self-propelled lifeline

### Description:

When it is not possible to set up sufficient collective protection for work carried out high up, the lifeline **SECURIFIL® automatique** is the appropriate solution to work in complete safety.

**SECURIFIL® automatique** is used with a tailor-made slider, which forms the interface between the cable and the En 362 compliant connector. This slider allows a smooth passage of the intermediate and angular parts.

### Details:

**Material:** Stainless steel

**Finish:** Raw

**Assembly:** Delivered with manuals and drawings available online at: <http://extranet.somain.fr>



### ✓ Advantages

- **Competitiveness**  
We were able to lighten the interface supports (posts, plates, fasteners, etc...) as the **SECURIFIL® automatique** significantly reducing stress in case of a fall.
- **Quality**  
All the parts are made of 316 stainless steel. It is guaranteed for 10 years against corrosion (excluding special environments)
- **Traceability**  
**SECURIFIL® automatique** has a unique serial number placed on its components.
- **Simplicity**  
**SECURIFIL® automatique** is used with a specific slider for smooth circulation.
- **Adaptability**  
**SECURIFIL® automatique** can be installed on all types of surfaces and roofs.  
*CAUTION: In case of angles, a second shock absorber is needed (except on hot deck).*
- **Centre distance**  
**SECURIFIL® automatique** can be installed with a centre distance of 15m between two intermediates. For distances greater than 15 m, choose the **SECURIFIL® renforcée**.
- **Users**  
**SECURIFIL® automatique** supports up to 4 users.

En cas de contraintes spécifiques, notre bureau d'étude est à même de vous proposer la solution adaptée.

En conformité avec la norme, un logiciel de calcul des efforts est disponible sur notre extranet ([extranet.somain.fr](http://extranet.somain.fr))

### ⋮ Options

Specific fixations for metal roofs: warm roofs, metal decks, standing seams.  
Specific RAL colour on request.

**+ Elements**

These components constitute all **SECURIFIL® automatique** lifelines.



**REF : 102416**

Stainless steel single anchoring end part.  
Fastening: 1M12



**REF : 102350**

Auto stainless steel intermediate part. Every 15 meters maximum  
Fastening: 1M12



**REF : 102173**

Stainless steel eye shock absorber, installed at one end of the lifeline, reduces stress on the structure in case of a fall.

- Traceability by unique serial number.
- Equipped with a tension and fall indicator.



**REF : 102422**

Auto. stainless steel bi-anchoring end part.  
Fastening: 2M12

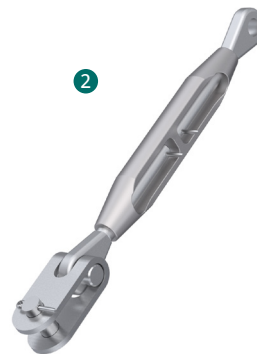

**REF : 100122**

Stainless steel eye/clevis tensioner, allows adjusting the tension of the lifeline during installation.

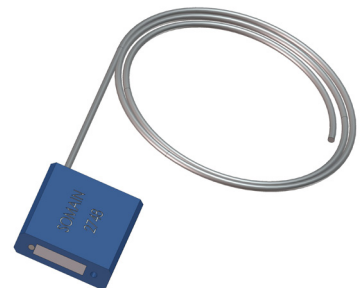

**REF : 100124**

SOMAIN Sealing. Attaches to tensioner to prevent cable tension from changing. Traceability by unique serial number.



**REF : 100150**

Stainless steel cable diameter 8 mm 7x19



**REF : 102131**

Aluminium cable clamp kit, diameter 8 mm + 1 stainless steel wire thimble diam. 8 mm.

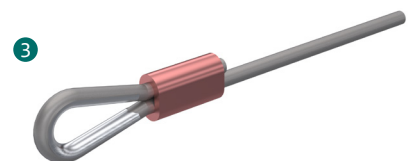

**REF : 100478**

Crimping set for stainless steel cable + stainless steel wire thimble 8 mm diameter.

## + Elements

These components constitute all **SECURIFIL® automatique** lifelines.

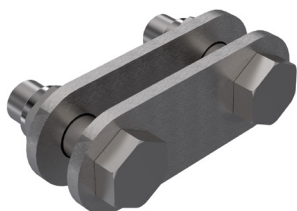

**REF : 102286**

Shock absorber/end part junction kit.



**REF : 100195**

Mandatory placard : Wearing of PPE, to be installed at each access to the lifeline. Available, on request, in the language of your choice with the possibility to insert your logo.

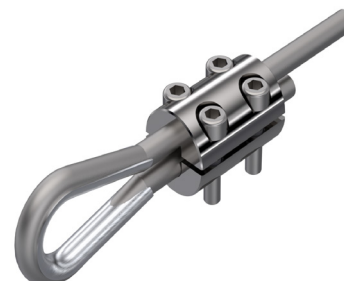

**REF : 101822**

Set, clamping nut + 8 mm diameter stainless steel core terminal.

These sliders are essential elements for the use of **SECURIFIL® automatique**. Without them, the system is not compliant.



**REF : 102425**

Stainless steel slider with **zinc-plated carabiner** allowing the smooth passage of intermediate parts. Locked by the carabiner, it allows users to free themselves at all points along the lifeline.

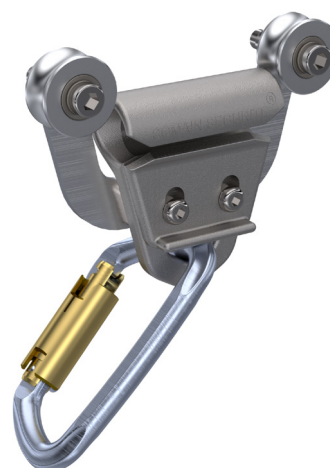

**REF : 102427**

Stainless steel slider for overhead use with **zinc-plated carabiner** allowing the smooth passage of intermediate parts. Locked by the carabiner, it allows users to free themselves at all points along the lifeline.

**REF : 102426**

Stainless steel slider with **stainless steel carabiner** allowing the automatic passage of intermediate parts. Locked by the carabiner, it allows users to free themselves at all points along the lifeline.

**REF : 102428**

Stainless steel slider for overhead use with **stainless steel carabiner** allowing the automatic passage of intermediate parts. Locked by the carabiner, it allows users to free themselves at all points along the lifeline.

**Fasteners**

In order to allow the passage of the intermediates in the best conditions, it's necessary to position the intermediate parts at notch 2 for a wall application.  
For an overhead use, the intermediate parts are fixed with a bracket to allow them to be installed on the surface and to offer the possibility of using a slider. The slider is designed to allow a smooth passage of the intermediate even with a retractable fall prevention device weighing up to 8kg

*Overhead application*

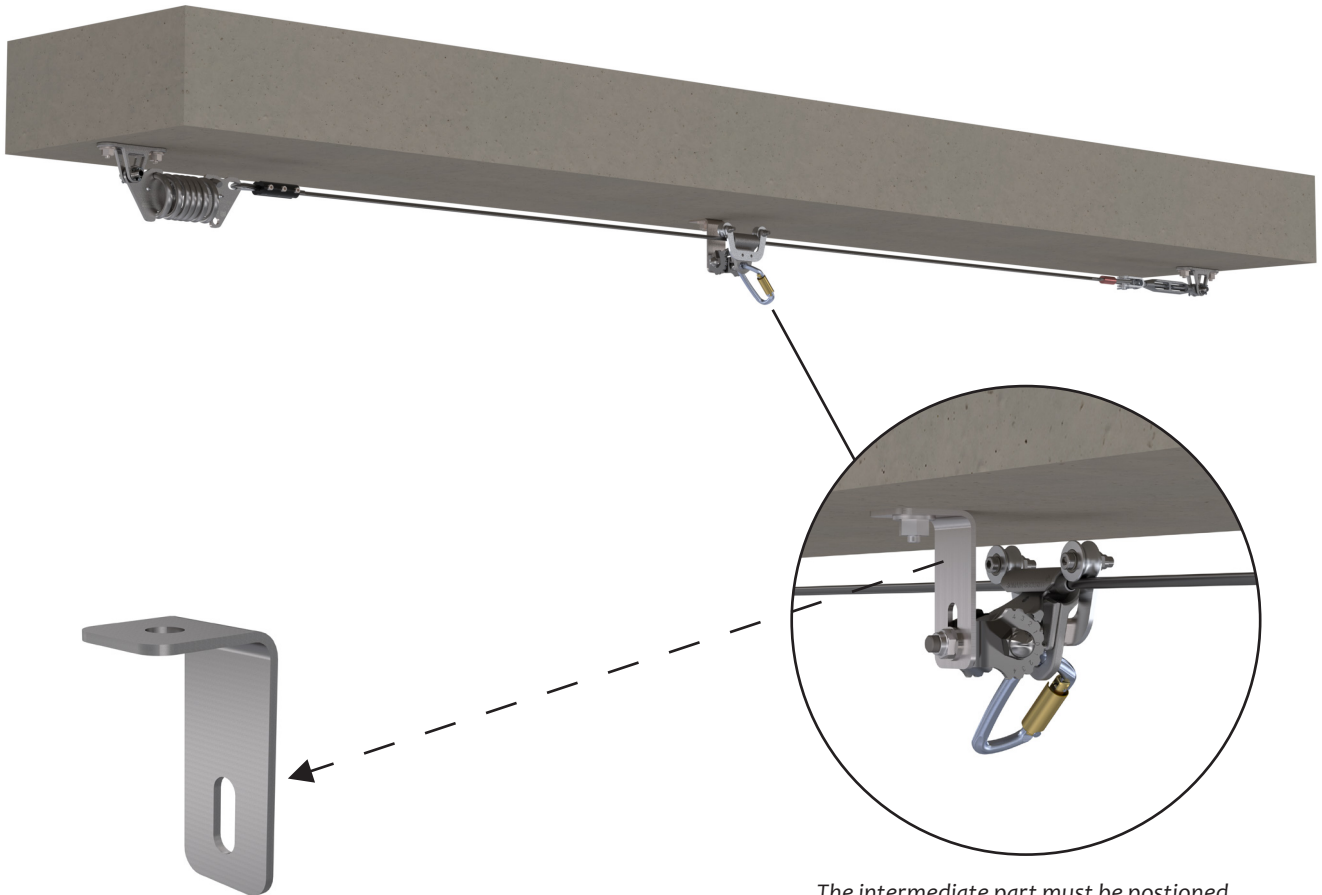

**REF : 102444**

Stainless steel underside bracket for intermediate part.  
Fastening: 1 M12

The intermediate part must be positioned at notch 2 for a wall application.

*Wall application*

